

Front/Rear Suspension Linkage Installation

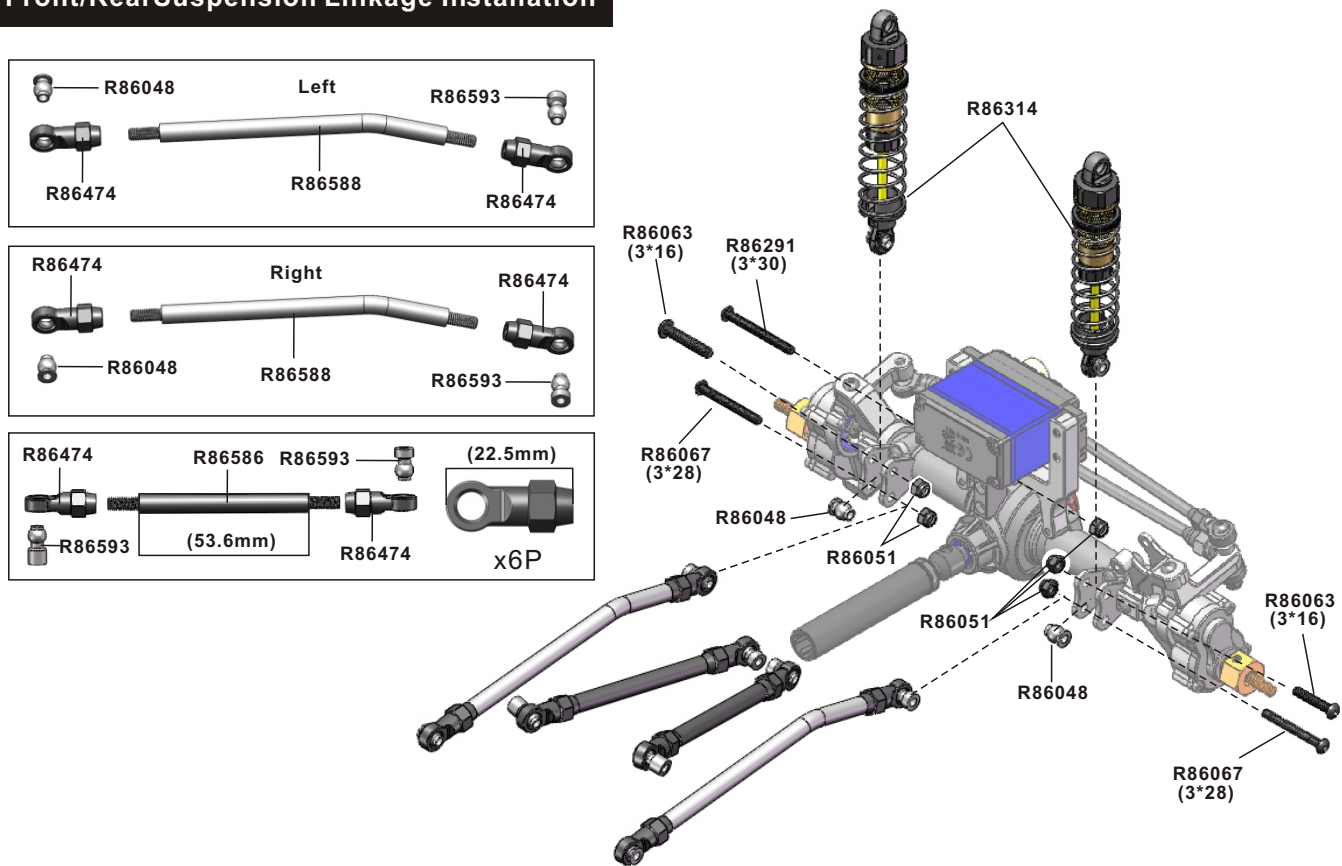

Transfer Case Assembly

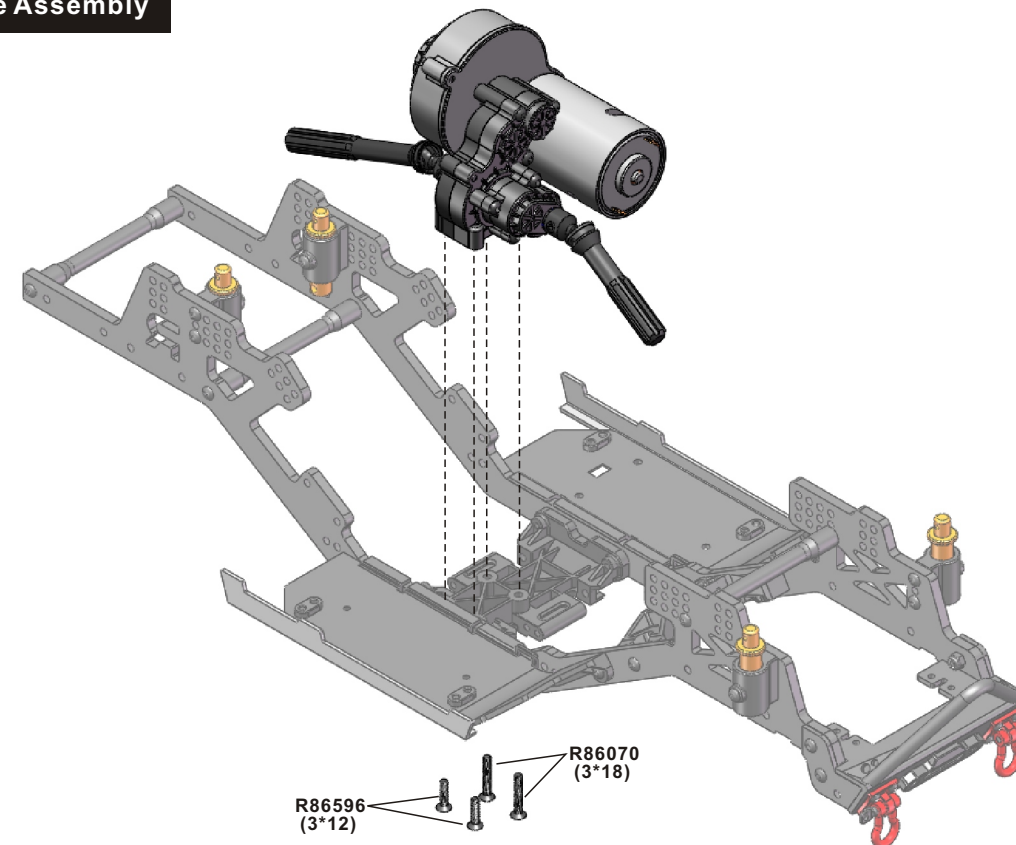

Chassis Rail Assembly

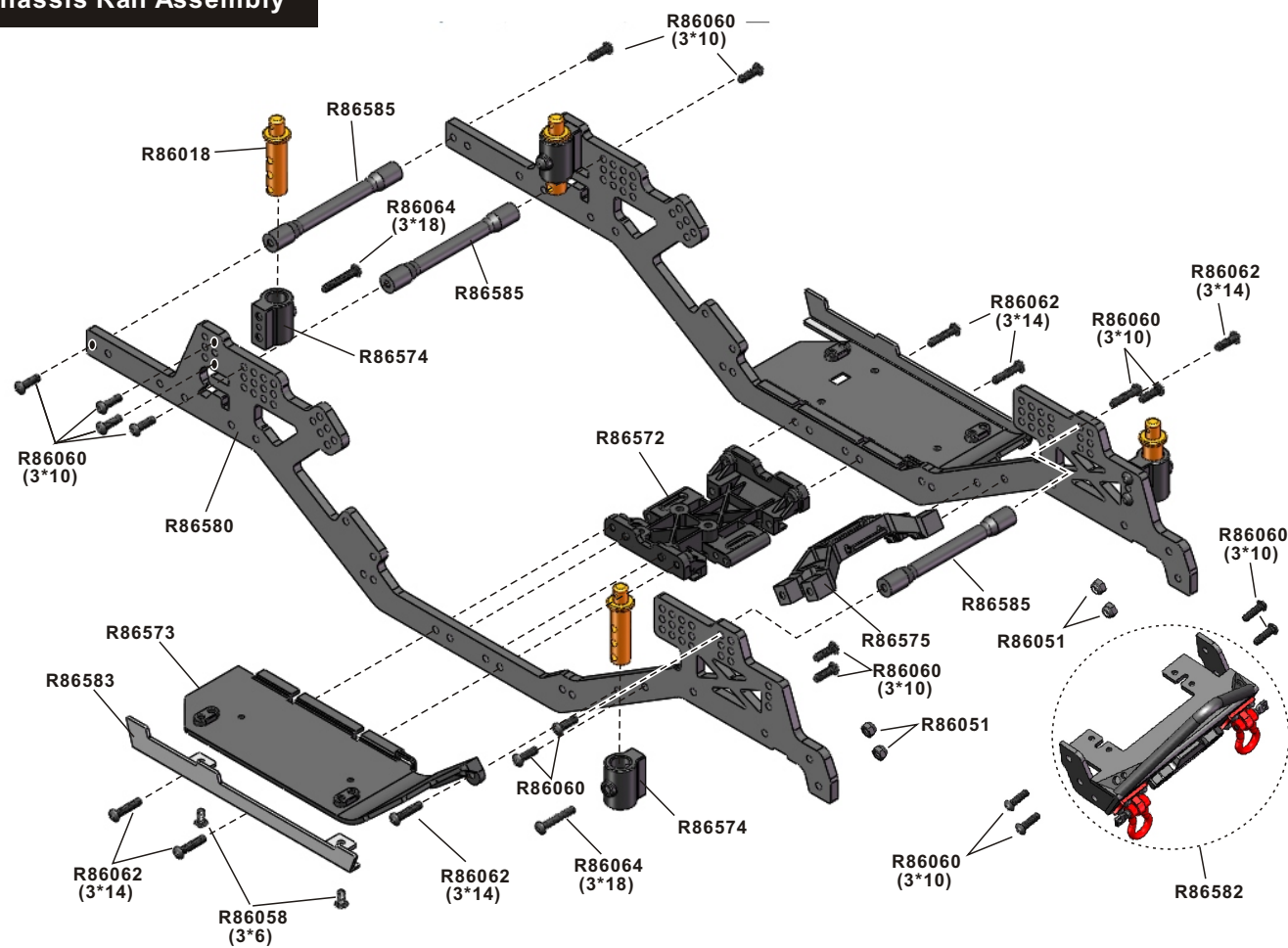

Installing FrontAxle Complete

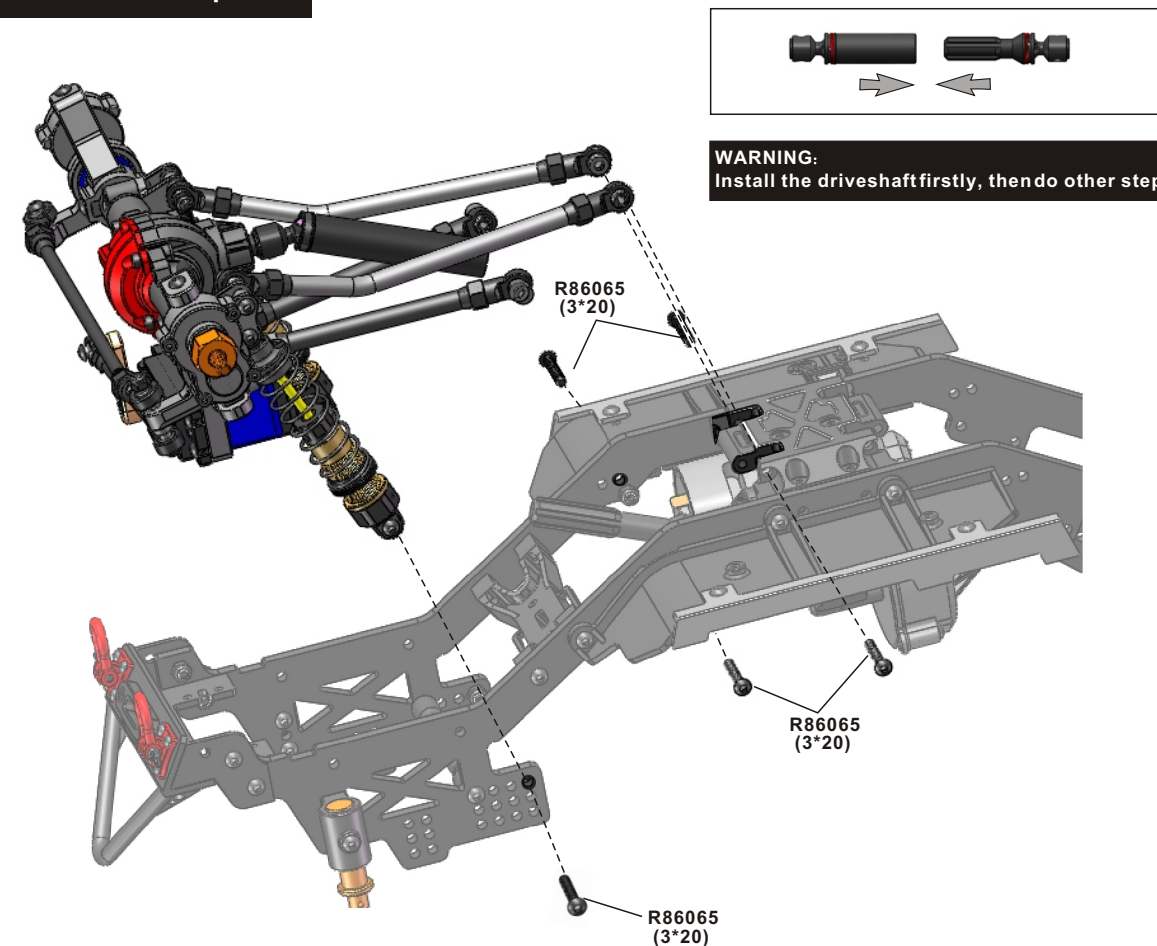

Installing RearAxle Complete

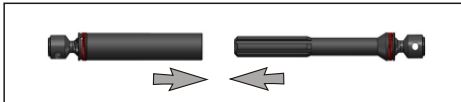
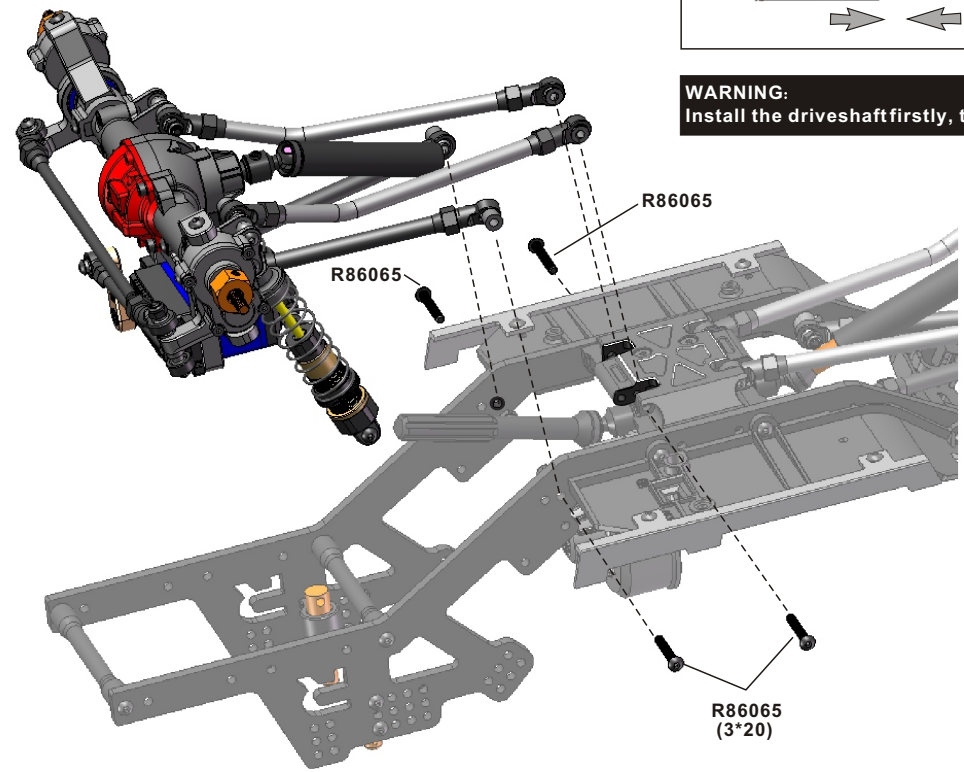

Installing Battery Holder

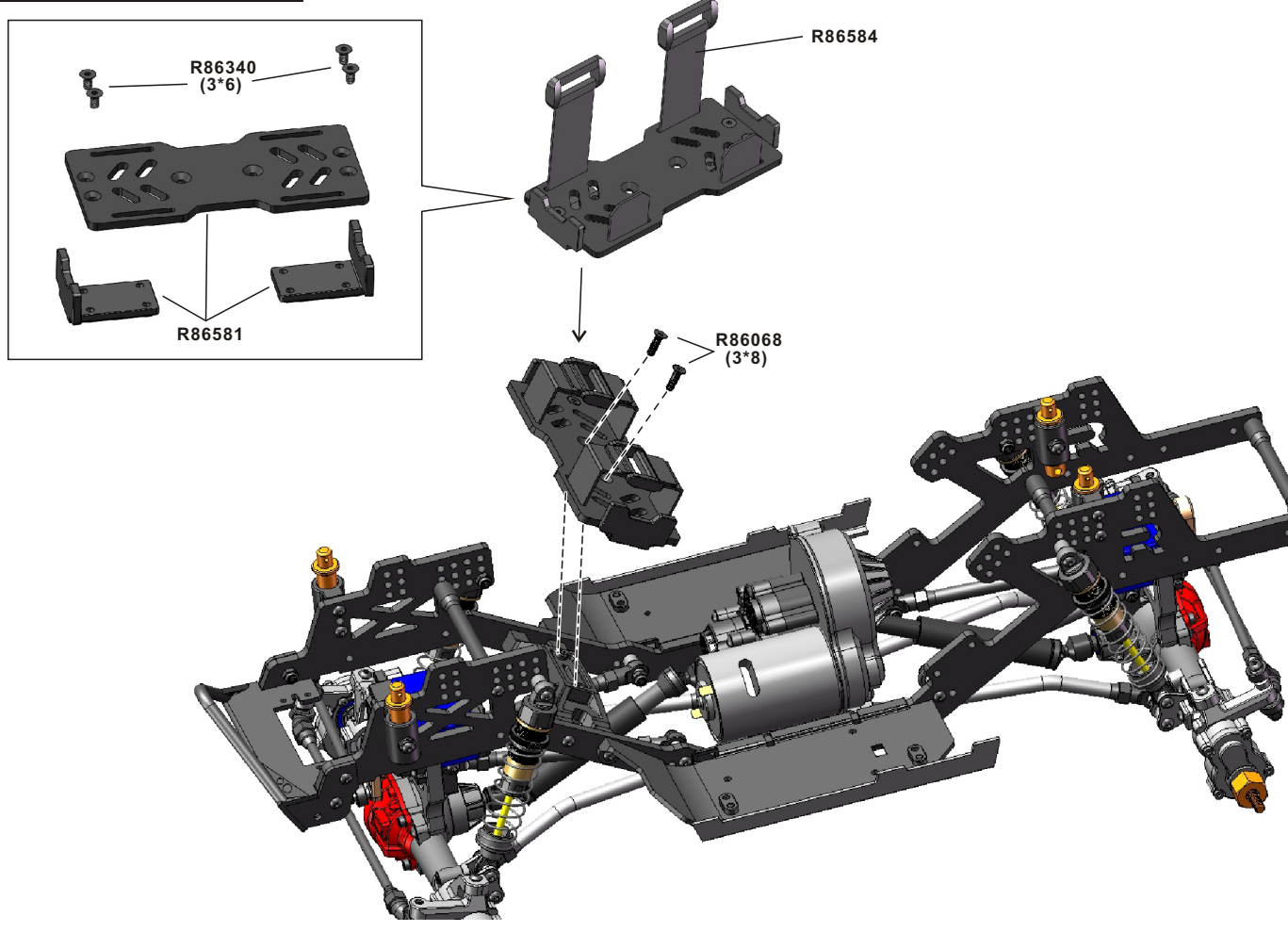

Installing ESC

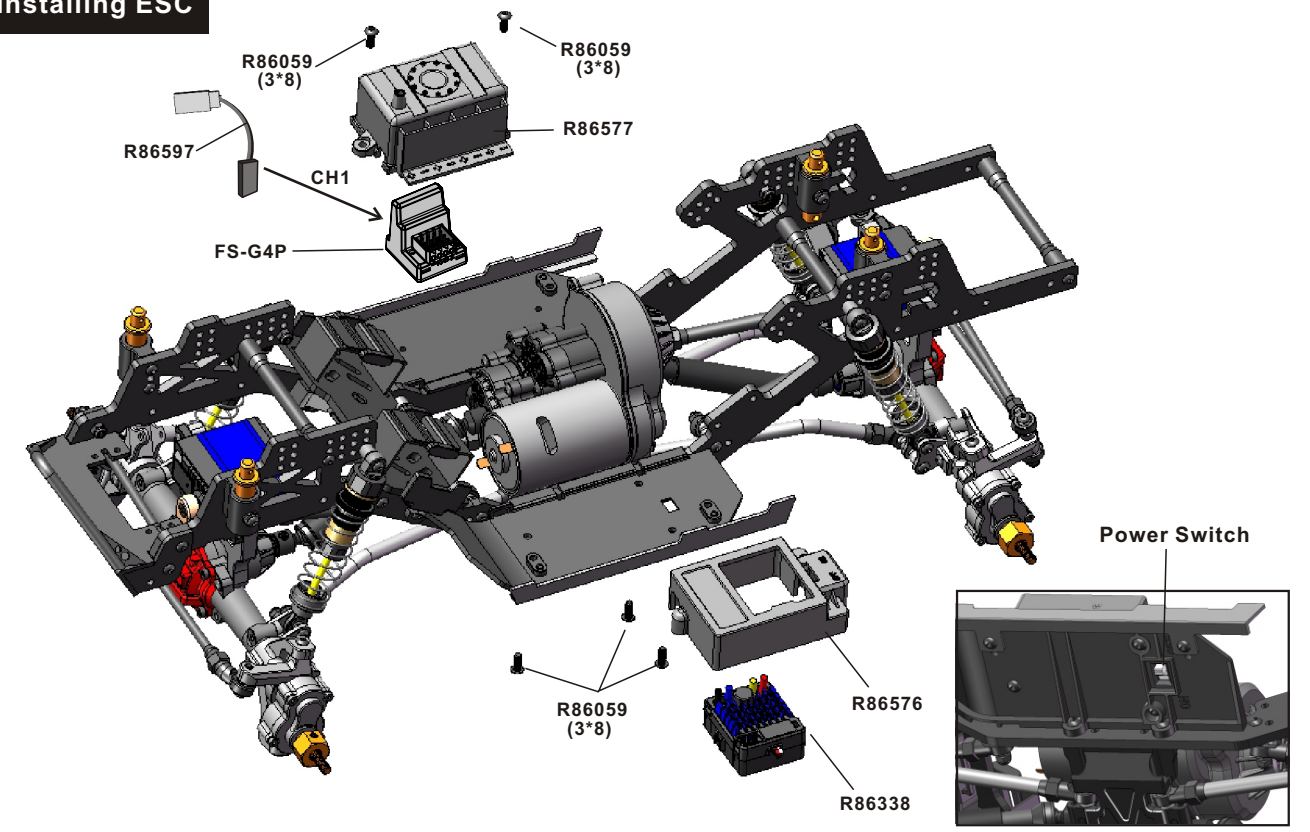

(Left)

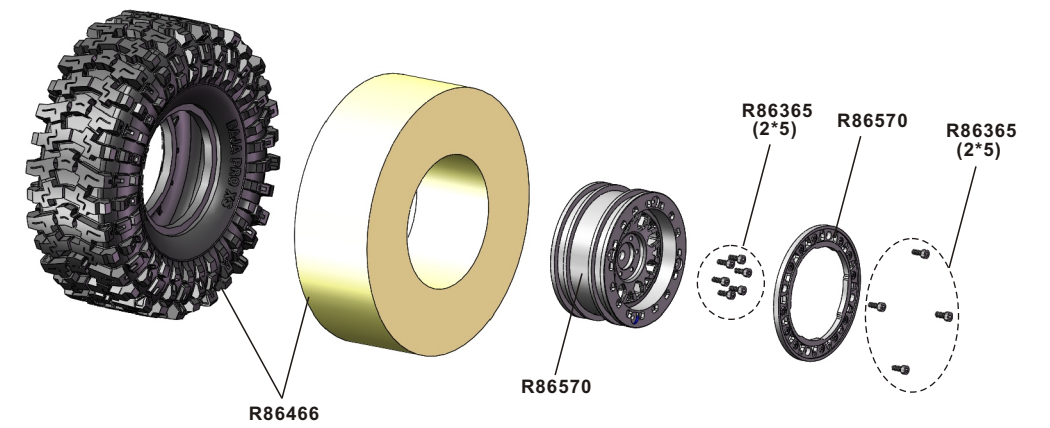



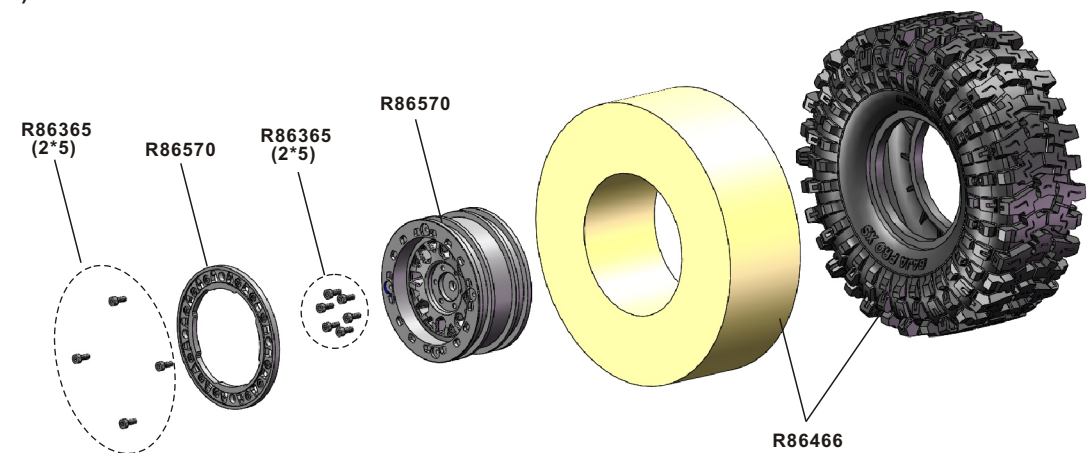

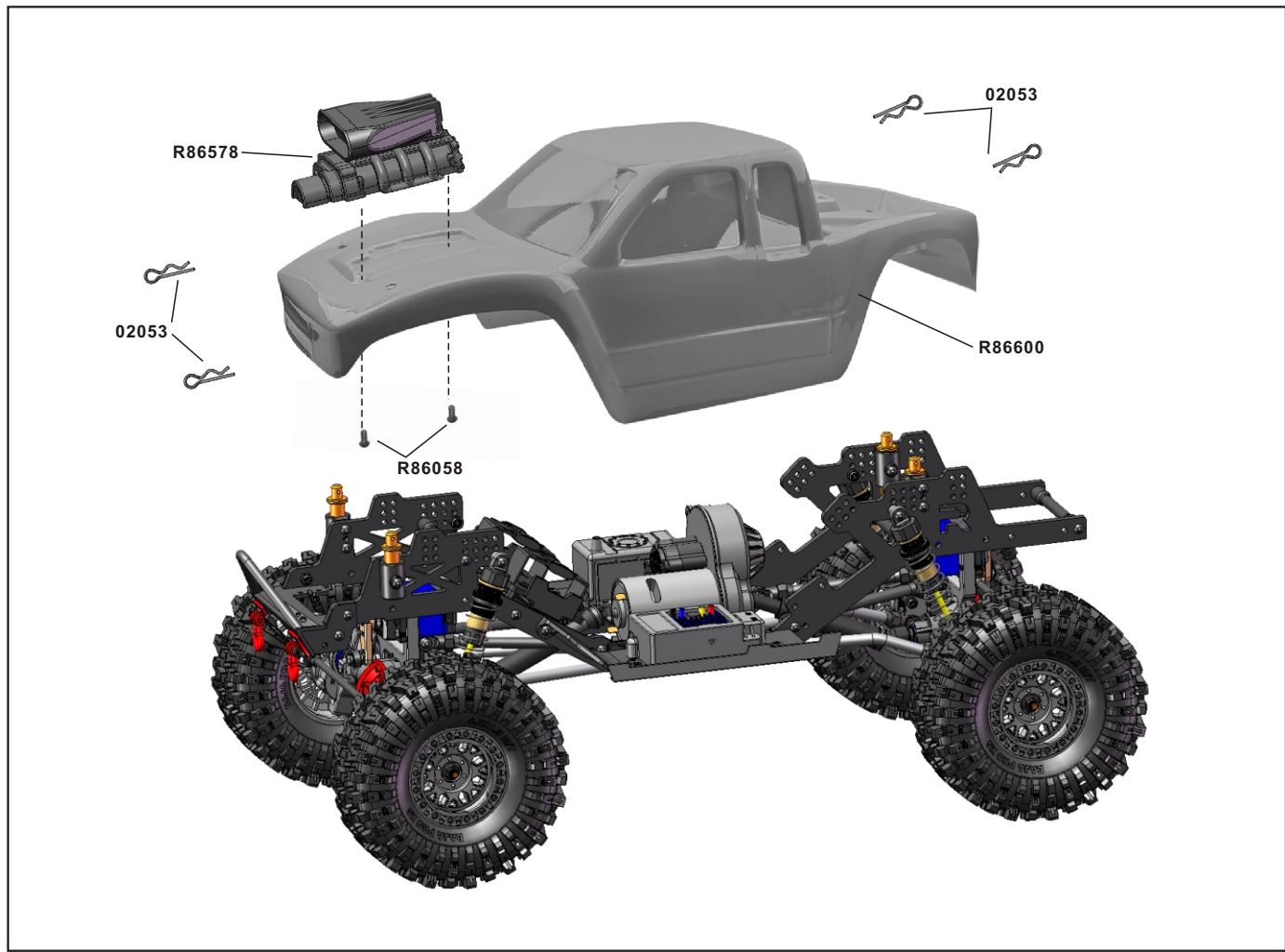
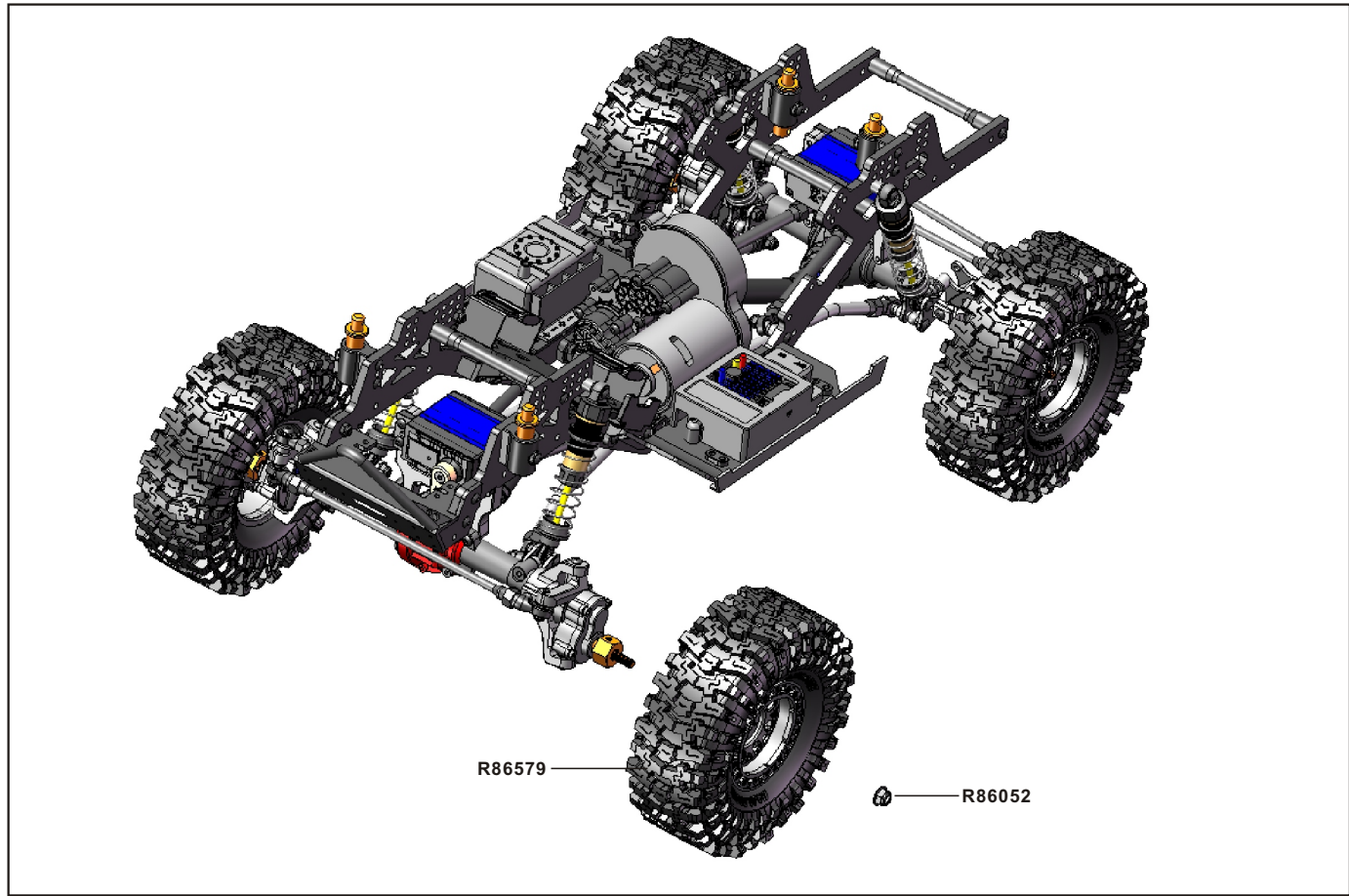





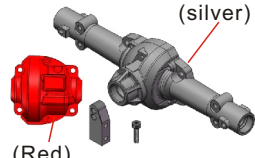
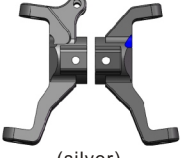
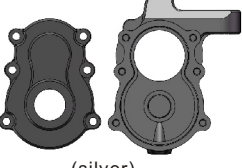
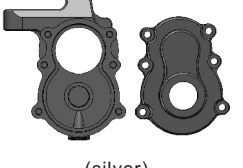

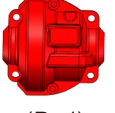

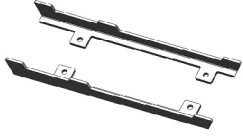
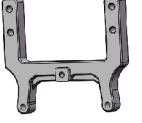



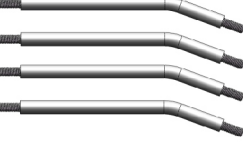

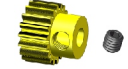

(Right)















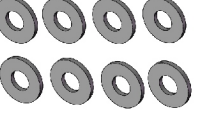

















Spare Part				
R86018 Body Post F/R	R86028 Main Gear set(87T)	R86085 Gear Mount	R86262 Distribution Housing	R86263 Motor Cover
R86572 Chassis Mount	R86573 Baffle B(L/R)	R86574 Body Post Mount	R86575 ECS Cable Connector	R86576 ESC Mount
R86577 Receiver Box	R86578 Engine Cover	R86474 Link Ends	R86581 Battery Mount	
R86570 Wheel Rim	R86466 Wheel Complete L/R	R86579 Tire W/Foam	R86580 Chassis Rail	
R86008 Drive Gear(16T)	R86009 Diff Main Gear(40T)	P860018 straight axle mount	R86591 Transmission Gear(28T)	R86598 CVD Drive shaft
R86244 Wheel Hub	R86255 Wheel Hex. W/Pins(2*10)	R86257 Motor Mount	R86279 Transmission GearSet	R86599-1 Rear Anti-Angle Holder

Spare Part

P860005-1  (silver) Mount for Link(AL.)	P860045-1  (Red) Front/Rear Axle Box(AL.)	P860049-1  (silver) Caster Mounts (L/R)(AL.)	P860050-1  (silver) Steering Mount R(AL.)	P860051-1  (silver) Steering Mount L(AL.)
R86311  (Long) Rear Drive Axle	R86590  (Short) Front Drive Axle	P860002  (Red) Axle Box Cover (AL.)	R86582  Front Bumper	R86583  Side Guards
P860101-1  (Silver) Servo Mount(AL.)	R86585  Joint Link	R86586  Upper Link 53.6mm	R86587  Servo link 56mm	R86588  Lower Link
R86589  Steering Link 112mm	R86436  Gear Shaft Set	R86044  Pinion Gear(14T)	R86046  Ball Bearingφ10*φ15*4	R86047  Ball Bearingφ5*φ10*4
R86316  Ball Bearingφ6*φ10*3	R86428  Ball Bearingφ4*φ8*3	R86246  Ball Bearingφ18*φ12*4	R86045  King Pin Bushing	R86048  Ball Stand φ5.9mm (Short)
R86049  Ball Stand φ5.9mm (Long)	R86592  Ball Stand φ5.0mm	R86593  Ball Stand φ5.9mm	R86051  Nylon Nut M3	R86052  Flange M4 Lock Nut

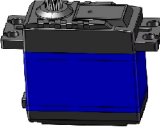
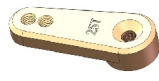





Spare Part

R86053  Crub Screw Bolt 3*3mm	R86054  Crub Screw Bolt 4*4mm	R86055  φ3*φ8*0.8 Metal Washer	R86057  Gasket(6.8*5*2)	R86594  E-Clips - φ 2.3mm*6P E-Clips - φ 4mm*6P
R86058  2.0 Button Head 3*6mm	R86059  2.0 Button Head 3*8mm	R86060  2.0 Button Head 3*10mm	R86061  2.0 Button Head 3*12mm	R86062  2.0 Button Head 3*14mm
R86063  2.0 Button Head 3*16mm	R86064  2.0 Button Head 3*18mm	R86065  2.0 Button Head 3*20mm	R86066  2.0 Button Head 3*25mm	R86067  2.0 Button Head 3*28mm
R86205  2.0 Button Head 3*15mm	R86291  2.0 Button Head 3*30mm	R86379  1.5 Button Head 2*4mm	R86072  2.0 Flat Head 2.5*10mm	R86340  2.0 Flat Head 3*6mm
R86068  2.0 Flat Head 3*8mm	R86596  2.0 Flat Head 3*12mm	R86070  2.0 Flat Head 3*18mm	R86365  1.5 Cap Head 2*5mm	R86289  1.5 Cap Head 2*8mm
R86071  2.0 Cap Head 2.5*8mm	R86320  2.0 Cap Head 2.5*11mm	R86076  Steering Servo 15KG	R86541  Servo Horn(25T)	R86538  Motor-550/8020

Spare Part

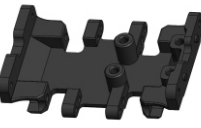
R86338	R86597	R86584	FS-G4P/4WS	PC Body+Sticker
 ESC - 60A	 Wire Head	 Batter Strap(L:250mm)	 Radio/Receiver	 R86600-0 (Clara) R86600-1 (Orange) R86600-2 (Gray White) R86600-3 (Dark Gray)
02053	R86314			
 Body Clip	 Shock Absorbers			

Optionals

P860065	P860066	P860096	P860097	P860098
 Wheel (AL.) (Black)	 Wheel (AL.) (Black)	 Copper Distribution Housing Weight Set 146g	 P860097-1(Silvery) Chassis Mount (AL.) (Black)	 P860098-1(Silvery) Distribution Housing(AL.) (Black)
P860099	P860100			
 P860099-1(Silvery) Motor Cover(AL.) (Black)	 P860100-1(Silvery) Motor Mount(AL.) (Black)			



PRODUCT QUALIFICATION CERTIFICATION

The product has conducted IQC (Input Quality Control) and full inspection before delivery. The manufacturer is responsible for quality assurance. Remote Control model is assembled manually, and then there may have some defects in the production process. Once the product is modified or incorrect operation, it cannot apply for replacement and return services, for the parts and accessories may be damaged.

Please contact the retail seller for after-sales service when needed.

The product conforms to technical requirements of export safety regulations.

Factory Address: Huang Jiang Town, Dong Guan City, Guang Dong Province, China

Website: www.RGT-RACING.Com

Production Date: refer to packing instruction