

# FURITEK LIZARD 20A/40A BRUSHED/BRUSHLESS ESC FOR AXIAL SCX24 WITH FOC TECHNOLOGY

## Features:

- Support sensorless brushless DC and brushed DC motor (config via app, default is brushless)
- FOC (Field-oriented control) technology
- Designed for AXIAL SCX24 crawlers.
- 5.5V-1.5A Built-in BEC
- Mini size and light weight
- Super easy programming via App on BOTH Android and IOS
- Firmware update available (bluetooth module required)
- Real-time telemetry up to 10Hz
- Support AAA batteries and 2s liPo batteries with automatic battery type recognition capability
- Ability to run with stock TX/RX or any other TX/RX

## Specifications:

- Dimension (mm): 24(L)x12.4(W)
- Weight: about 2.1g
- Battery types: 4 AAA NiMH/2s liPo/ 2s LiOn
- Motor type: Sensored/Sensorless Brushless DC / Brushed DC
- BEC output: 5.5V/1.5A
- Constant Current : 20A
- Burst Current : 40A
- Waterproof : NO

## Pinout:

**Battery input:**  
Support AAA/2s liPo batteries

Bat- Bat+

**ESC Signal**  
(configure page 3)

**Bluetooth**  
(configure page 4)

**Start/Stop button**  
(configure page 3)

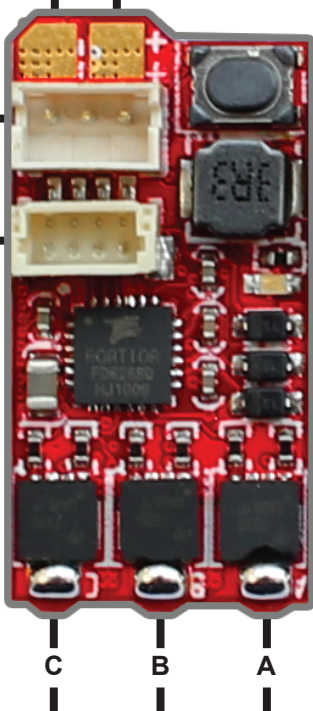

C B A

**Motor output: Default (Brushless motor)**  
Brushless or brushed motor (configure page 2)



FURICAR



SCAN ME ON APP



## Connect Brushed/Brushless motor to ESC:

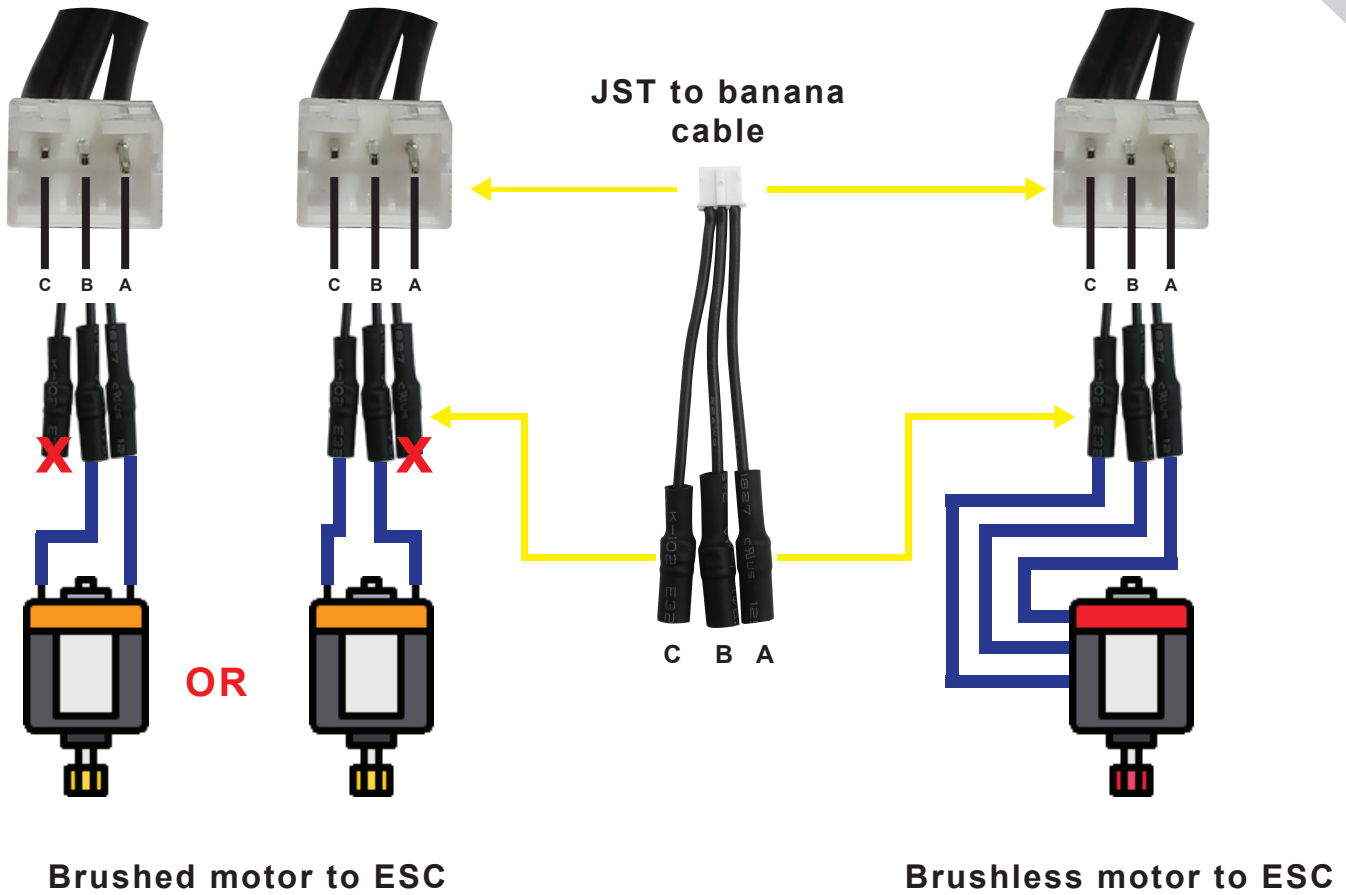

**\*DEFAULT configuration is Brushless motor, if you use BRUSHED motor, please configure it as below:**

- **Step 1:** Please make sure to plug your battery to esc and open FURICAR app on android or IOS device
- **Step 2:** Please Click the Setting icon (see picture) 
- **Step 3:** Please click "Motor Type" menu, a new window pops up, select "Brushless" or "Brushed" and then click "OK"

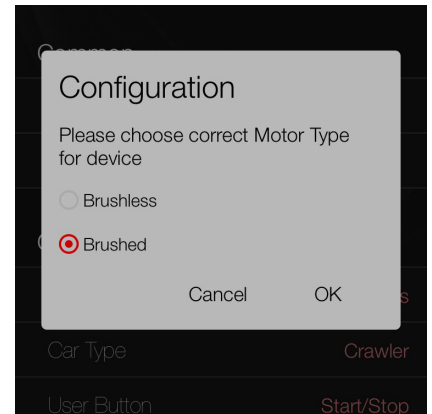
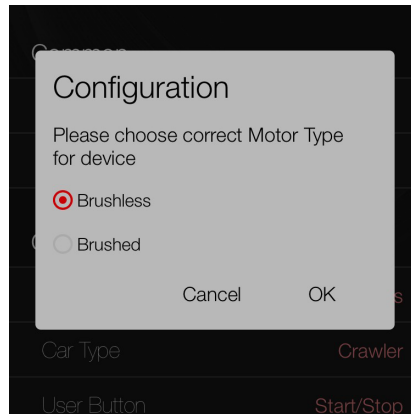
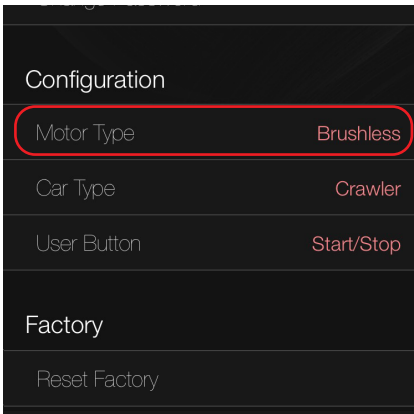

## Start/Stop button:

- Press the button to turn on the power for “motor, external receiver, bluetooth” and press again to turn off the power.

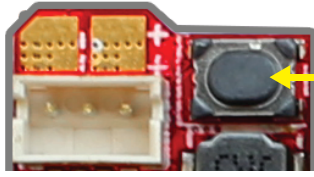

Start/Stop Button

## \*User button default is Start/Stop, if you change, please configure it at below:

- **Step 1:** Please make sure to plug your battery to esc and open FURICAR app on android or IOS device
- **Step 2:** Please Click the Setting icon (see picture)
- **Step 3:** Please Click “User Button” menu, a new window pops up, select “None”, “Start/Stop” or “Start/Stop with 2s pressed” and then click “OK”

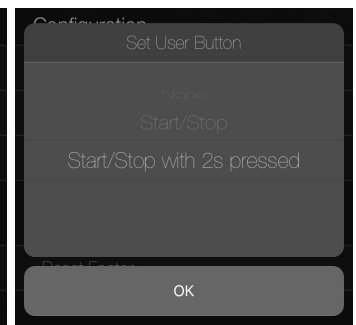
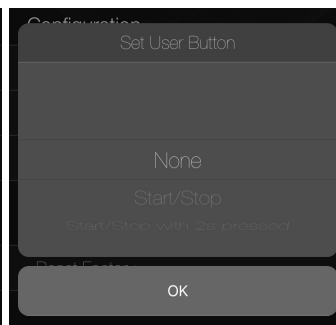
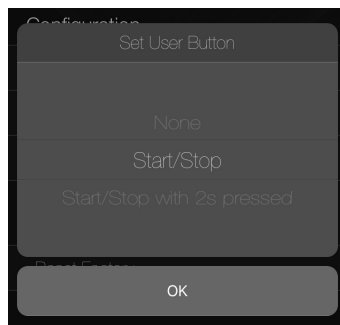
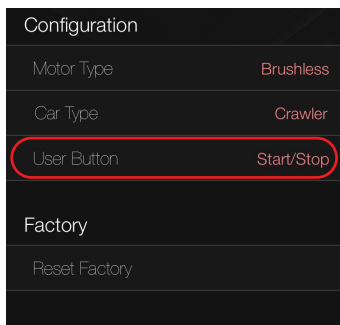

## Esc Manual calibration:

### A. Calibration on ESC Mainboard:

- **Step 1:** Please make sure to plug the battery to your esc
- **Step 2:** Press and hold the button of ESC (wait for 6 secs and the ESC LED indicator will start blinking followed by a motor beeping sound)
- **Step 3:** Set to 0% Throttle or lowest speed (please make sure that your radio throttle stick at NEUTRAL POSITION, press the ESC button, ESC LED indicator will blink 1 time and motor will beep 1 time)
- **Step 4:** Set to 100% Throttle or Maximum speed (move your radio throttle stick FORWARD and press the ESC button, ESC LED indicator will blink 2 times and motor will beep 2 times)
- **Step 5:** Setting up of your BRAKE (move the radio throttle stick BACKWARD and press the ESC button, ESC LED indicator will blink 3 times and motor will beep 3 times)
- **Step 6:** When your ESC show 4 blinking LED light and your motor beep 4 times mean you successfully CALIBRATED your Furitek ESC

### B. Calibration via App: (Your esc need a Bluetooth to communicate with app)

- **Step 1:** Please make sure to plug your battery to esc and open FURICAR app on android or IOS device
- **Step 2:** Please click “MENU” and click “THROTTLE”
- **Step 3:** Please click “CALIB” and then click “YES”

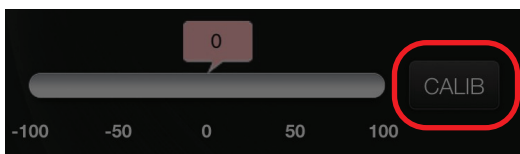

**\*Follow intructions on the app screen till fishnish calibration**



## Bluetooth:

- Default password to connect via Bluetooth "1234"

## \*Change password:

- **Step 1:** Please make sure to plug your battery to esc and open FURICAR app on android or IOS device

- **Step 2:** Please Click the Setting icon (see picture)

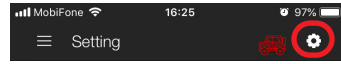

- **Step 3:** Please Click "Change Password" menu, a new window pops up, type your new password and then click "OK"

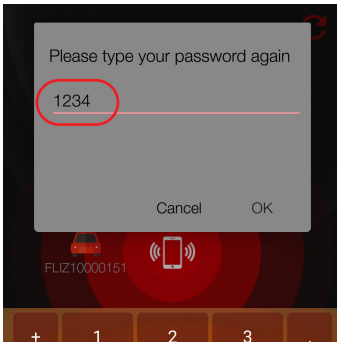

**Default password:  
1234**

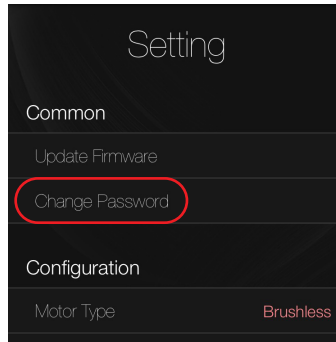

**Change password**

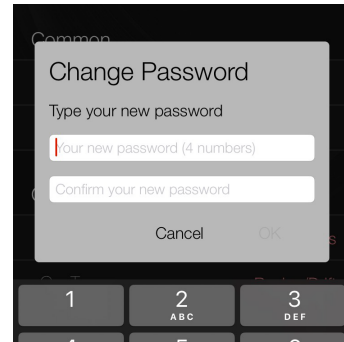

## Choose Channel2 to connect Receiver to ESC main board:

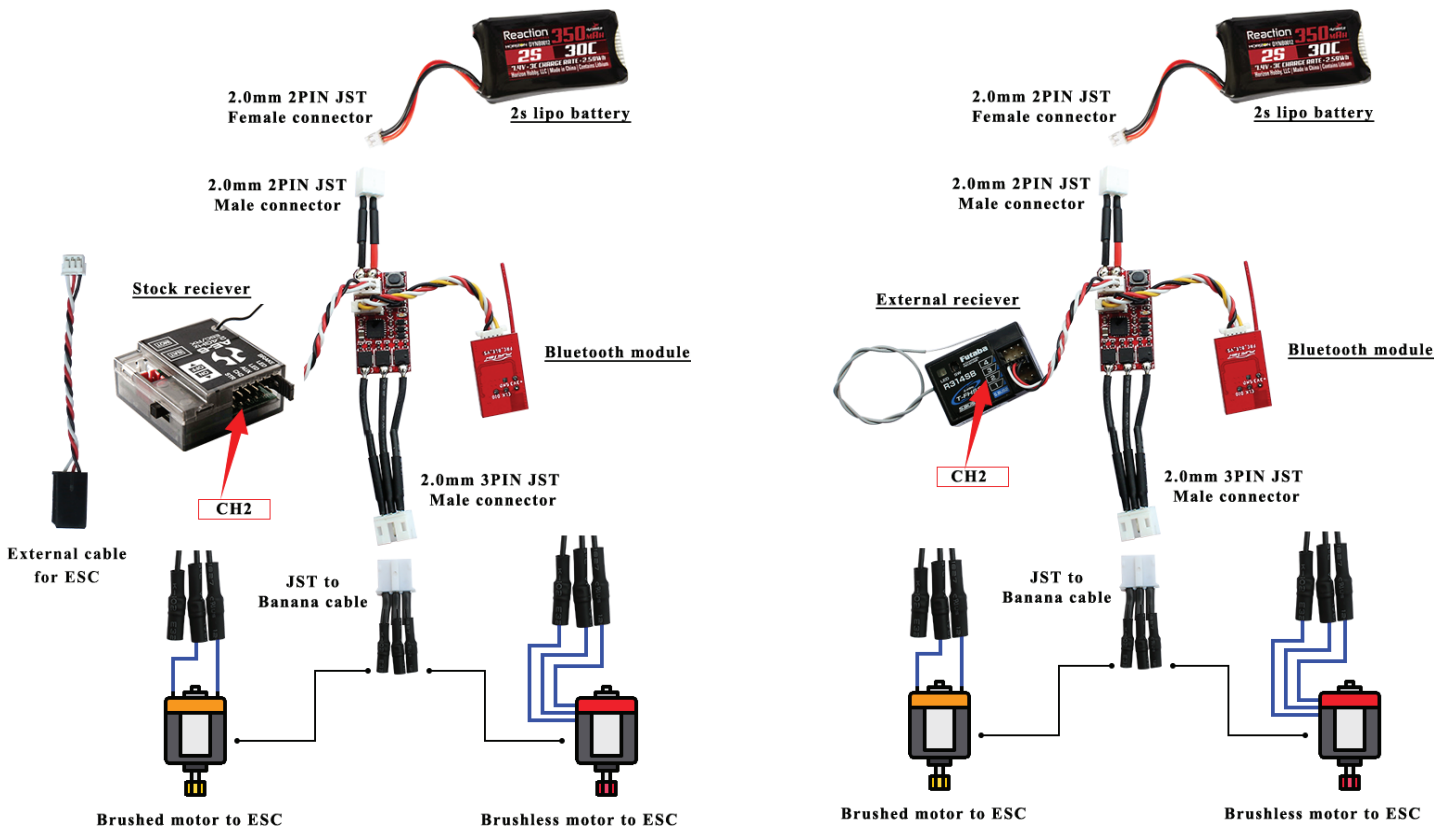

**Connection Diagram for stock receiver/radio**

**Connection Diagram for external receiver**

